

# Bibel-Stammbaum

*L12*: Luther 1912

*L84*: Luther 1984

*Ei*: Einheitsübersetzung 1980

*Z*: Zürcher 1931

*S*: Franz Eugen Schlachter 1952

*rEl*: revidierte Elberfelder 1985

*El*: Elberfelder 1905

*M*: Dr. Hermann Menge 1926 / 11. Auflage 1949

*TS*: N.H. Tur-Sunai 1954 (nur AT)

zu klären:

- 1.Chr.2/18 Zeugten Kaleb und Asuba die Jerigoth oder war Jerigoth eine weitere Frau Kaleb's?
- 1.Chr.2/24 Wer ist Abia?
- 1.Chr.4/3-4: Wo einzuordnen?
- 1.Chr.4/8-?: Wo einzuordnen?
- 1.Chr.4/11-12: Wo einzuordnen?
- 1.Chr.4/13: Kenan: Wo einzuordnen? 1.Chr.4/15, Sohn des Ela?
- 1.Chr.4/15: Jephunnes: Wo einzuordnen?
- 1.Chr.4/16: Perez: Wo einzuordnen?
- 1.Chr.4/18-20
- 1.Chr.4/28-43 Namen?
- 1.Chr.5/4: Joel?
- 1.Chr.5/7-8
- 1.Chr.6/7: Kahtath.: Wo einzuordnen?
- 1.Chr.6/10: Welcher Elkana? 2.Mose6/24?
- 1.Chr.6/11: Wessen Söhne? Amasai's oder Ahimoth's?
- 1.Chr.6/24-28: Gerson's Sohn Libni fehlt, auch die Namen sind alle nur ähnlich. Jahat wird vorher nicht als Sohn Gersons genannt.

1



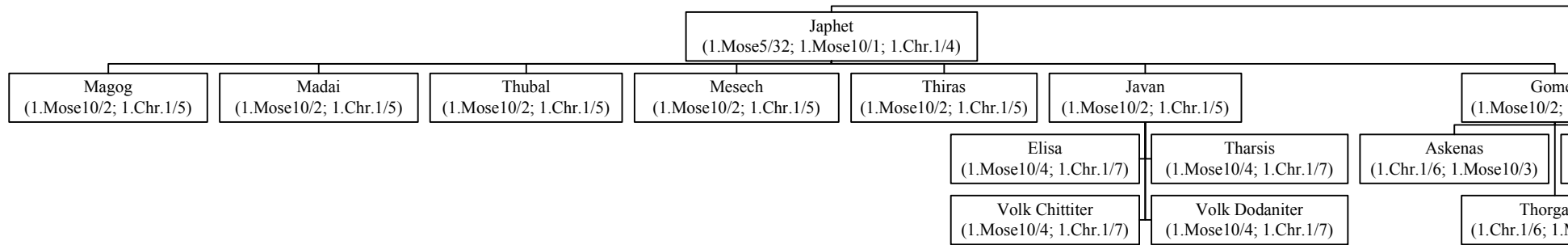

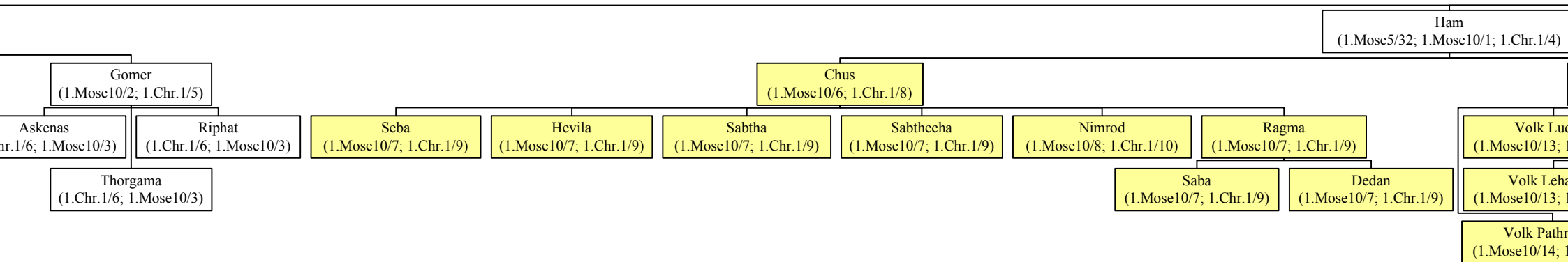

**GOTT**  
(1.Mose1/?; Luk.3/38)

Adam & Eva  
(1.Mose3/8+20; 1.Chr.1/1; Luk.3/38)

Kain  
(1.Mose4/1)

Seth  
(1.Mose4/25; 1.Chr.1/1; Luk.3/38)

Abel  
(1.Mose4/2)

Henoeh  
(1.Mose4/17)

Enos  
(1.Mose4/25; 1.Chr.1/1; Luk.3/38)

Irad  
(1.Mose4/18)

Kenan  
(1.Mose5/9; 1.Chr.1/2; Luk.3/38)

Mahujael  
(1.Mose4/18)

Mahalaleel  
(1.Mose5/12; 1.Chr.1/2; Luk.3/37)

Methusael  
(1.Mose4/18)

Jared  
(1.Mose5/15; 1.Chr.1/2; Luk.3/37)

Lamech & Zilla  
(1.Mose4/18)

Lamech & Ada  
(1.Mose4/18)

Henoeh  
(1.Mose5/18; 1.Chr.1/3; Luk.3/37)

Thubalkain  
(1.Mose4/22)

Jabal  
(1.Mose4/20)

Methusalah  
(1.Mose5/21; 1.Chr.1/3; Luk.3/37)

Naema (w)  
(1.Mose4/22)

Jubal  
(1.Mose4/21)

Lamech  
(1.Mose5/25; 1.Chr.1/3; Luk.3/37)

Noah  
(1.Mose5/29; 1.Mose10/1; 1.Chr.1/4; Luk.3/36)

Ham  
(1.Mose10/1; 1.Chr.1/4)

Mizraim (Ei: Ägypten)  
(1.Mose10/6; 1.Chr.1/8)

Put  
(1.Mose10/6; 1.Chr.1/8)

Kanaan  
(1.Mose9/18; 1.Mose10/14;  
1.Chr.1/8)

Volk Luditer  
(1.Mose10/13; 1.Chr.1/11)

Volk Anamiter  
(1.Mose10/13; 1.Chr.1/11)

Volk Lehabiter  
(1.Mose10/13; 1.Chr.1/11)

Volk Naphthuhiter  
(1.Mose10/13; 1.Chr.1/11)

Volk Pathrusiter  
(1.Mose10/14; 1.Chr.1/12)

Volk Kaphthoriter  
(1.Mose10/14; 1.Chr.1/12)

Volk Philister  
(1.Chr.1/12 (Z, L84); Jer.47,4;  
Amos9,7 (nicht in Ei))

Sidon  
(1.Mose10/15; 1.Chr.1/13)

Heth  
(1.Mose10/15; 1.Chr.1/13)

Volk Jebusiter  
(1.Mose10/16; 1.Chr.1/14)

Volk Amoriter  
(1.Mose10/16; 1.Chr.1/14)

Volk Girgasiter  
(1.Mose10/16; 1.Chr.1/14)

Volk Heviter  
(1.Mose10/17; 1.Chr.1/15)

Volk Arkiter  
(1.Mose10/17; 1.Chr.1/15)

Volk Siniten  
(1.Mose10/17; 1.Chr.1/15)

Peleg  
(1.Mose10/25; 1.Mose11/16;  
1.Chr.1/19; Luk.3/35)

Abel  
(1.Mose4/2)

/36)

---

---

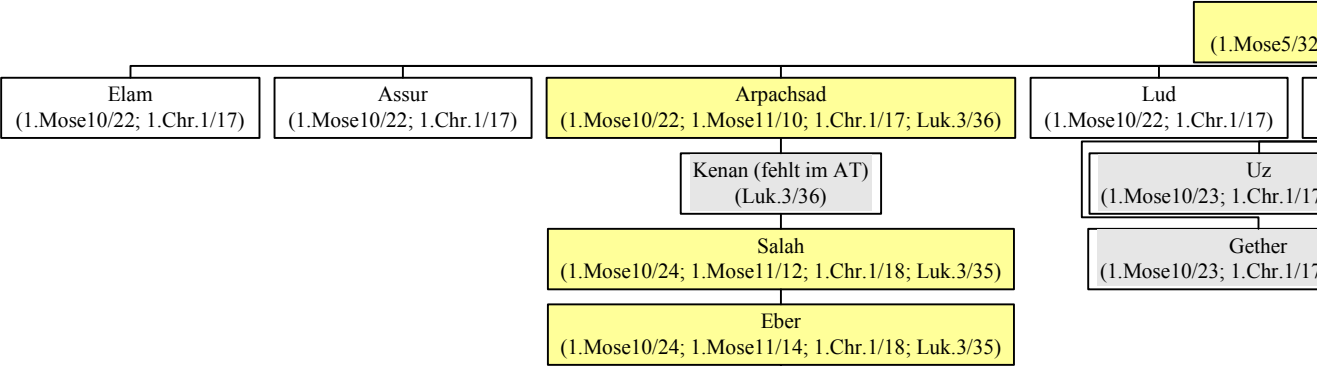

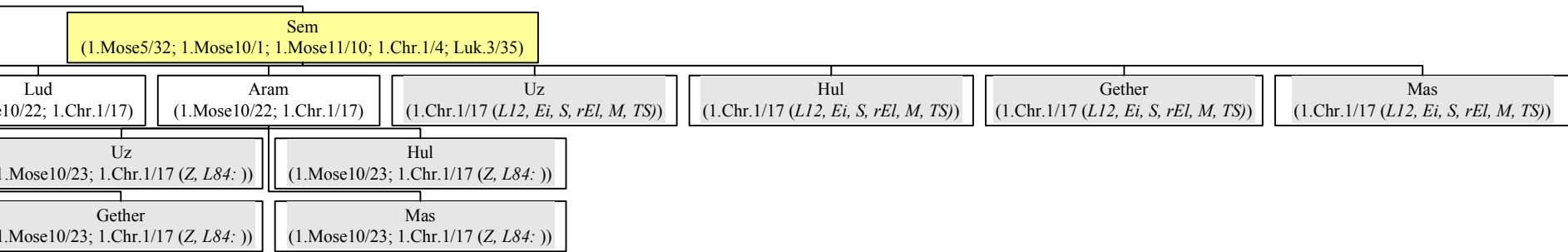



Joktan  
(1.Mose10/25; 1.Chr.1/19)

Almodad

Saleph

uktan  
25; 1.Chr.1/19)

Saleph

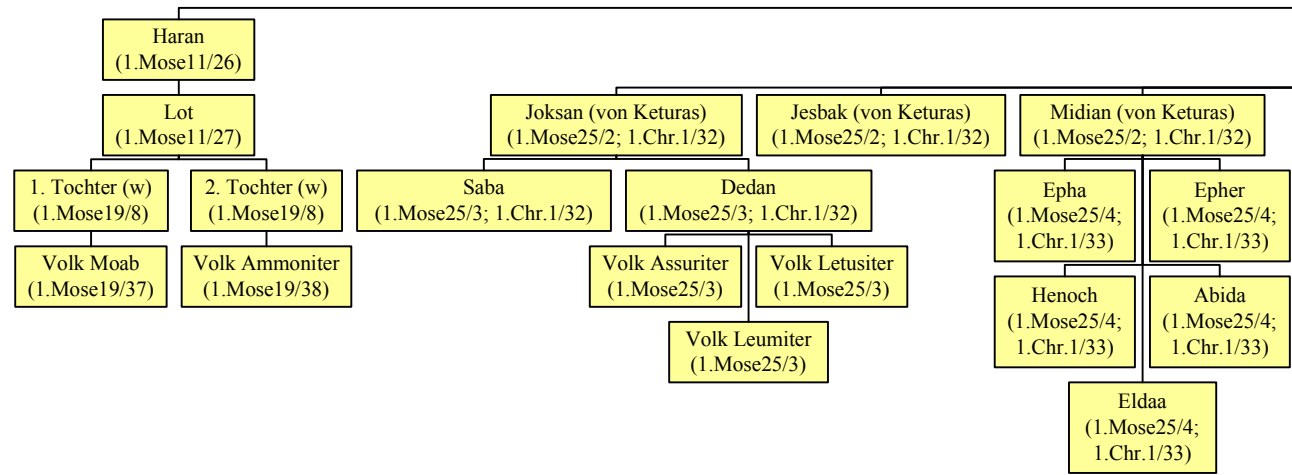

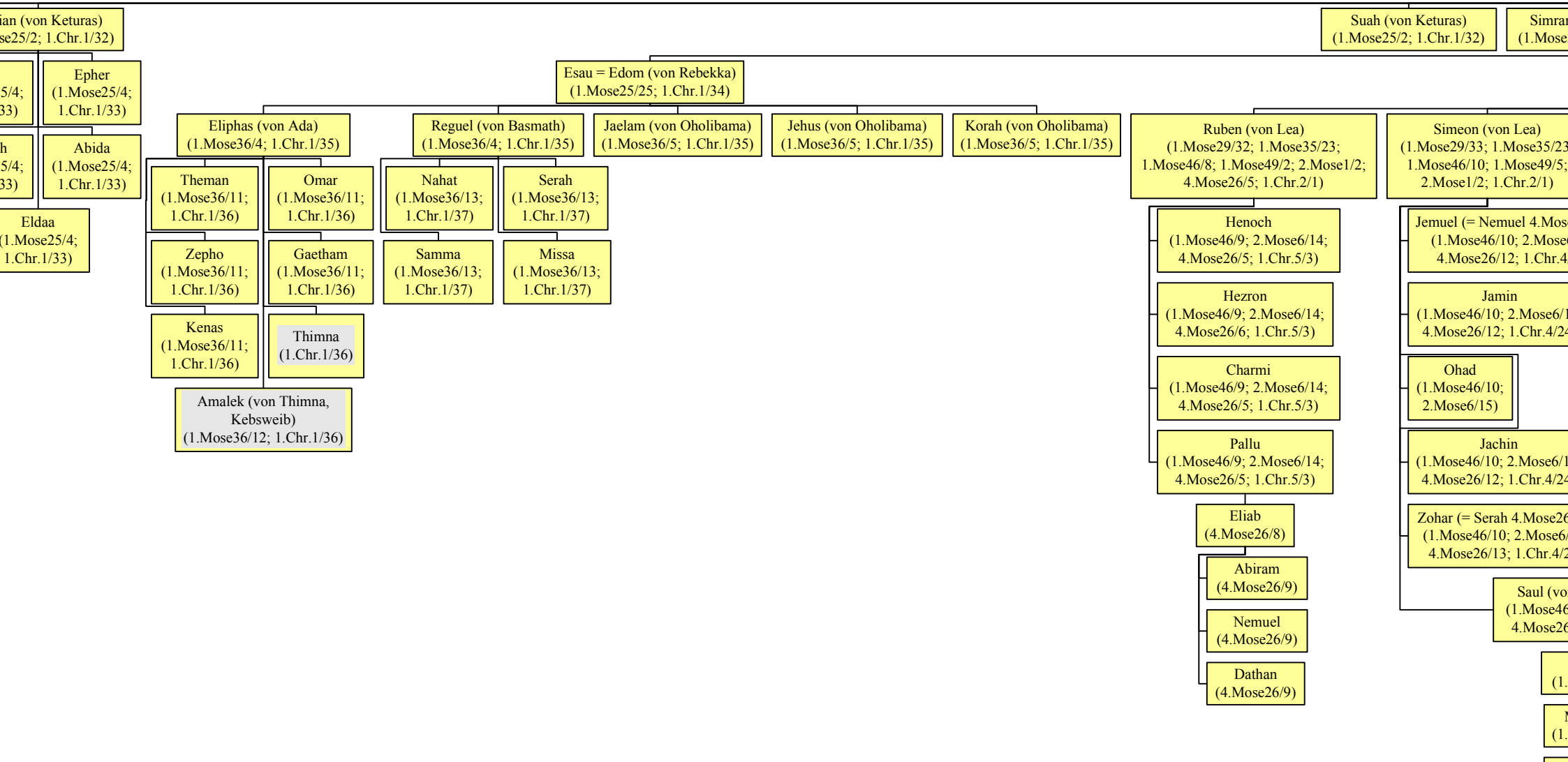

Keturas  
(1.Chr.1/32)

Simran (von Keturas)  
(1.Mose25/2; 1.Chr.1/32)

Medan (von Keturas)  
(1.Mose25/2; 1.Chr.1/32)

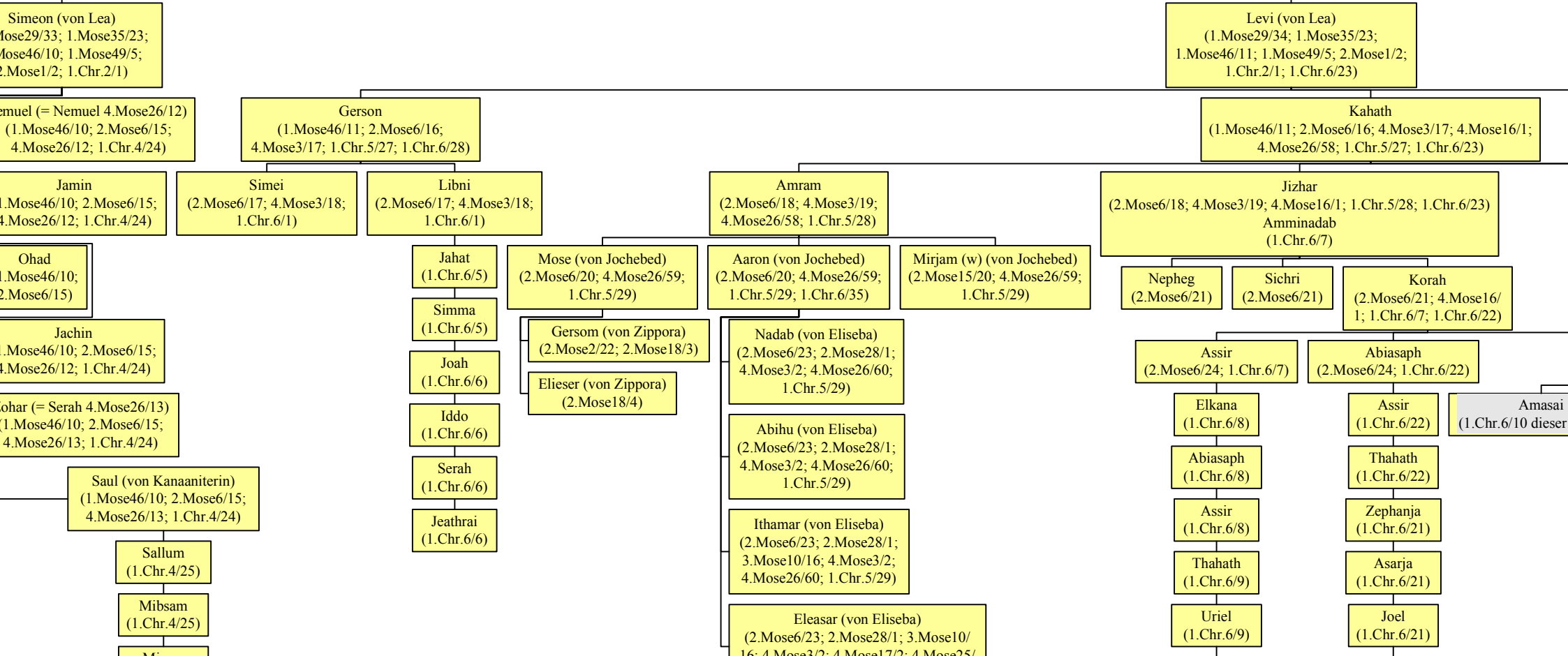



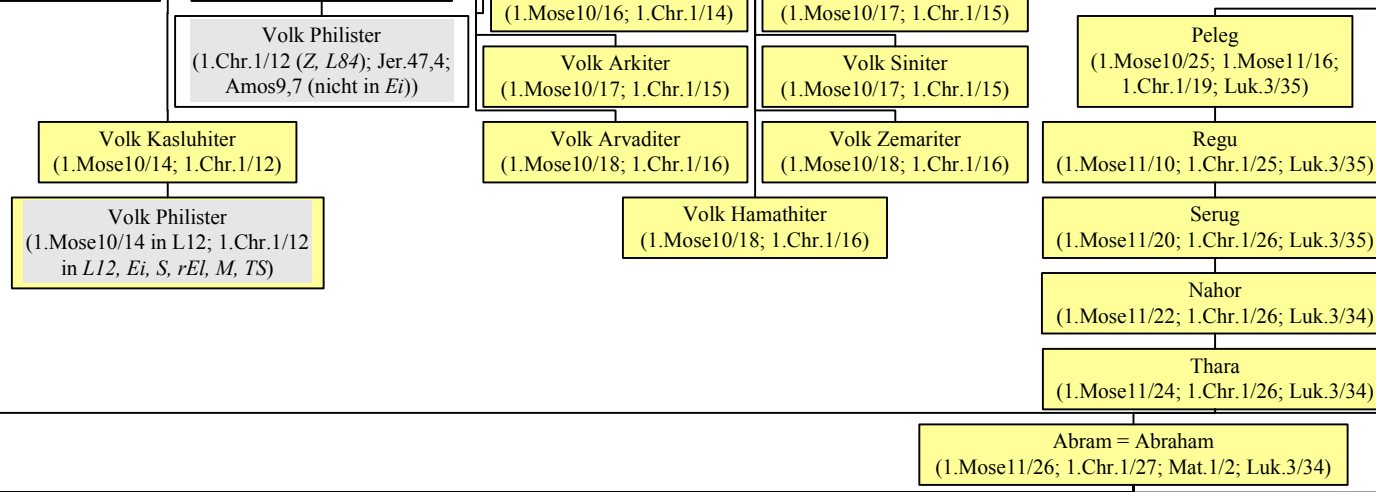

Jakob = Israel (von Rebekka)  
(1.Mose25/25; 1.Chr.1/34; Mat.1/2; Luk.3/38)

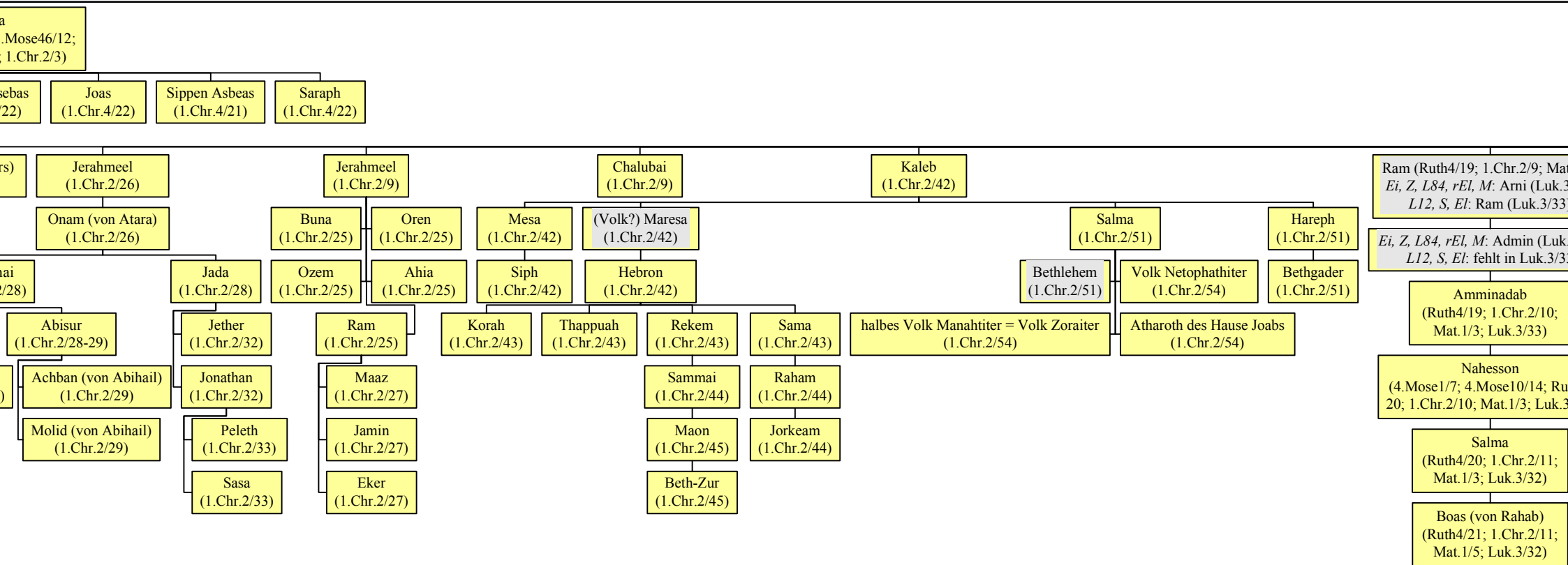

= Israel (von Rebekka)  
1.Chr.1/34; Mat.1/2; Luk.3/34)

Juda (von Lea)  
(1.Mose29/35; 1.Mose35/23; 1.Mose46/12;  
1.Mose49/8; 2.Mose1/2; 4.Mose26/19;  
1.Chr.2/1; Mat.1/2; Luk.3/33)

Perez (von Thamar)  
(1.Mose38/29; 1.Mose46/12; 4.Mose26/20;  
1.Chr.2/4; Mat.1/3; Luk.3/33)

Hezron  
(1.Mose46/12; 4.Mose26/21; Ruth4/18;  
1.Chr.2/5; Mat.1/3; Luk.3/33)

Hamul  
(1.Mose46/12;  
4.Mose26/21; 1.Chr.2/5)

Ruth4/19; 1.Chr.2/9; Mat.1/3)  
L84, rEl, M: Armi (Luk.3/33)  
2, S, El: Ram (Luk.3/33)

Karmi  
(1.Chr.4/1)

Ei, Z, L84: Kaleb & Asuba  
(1.Chr.2/18)

L12, S, rEl, M, TS: Kaleb & Asuba & Jerigoth  
(1.Chr.2/18)

Kaleb & Ephratha  
(1.Chr.2/19)

Kaleb & Abia  
(1.Chr.2/24)

L84, rEl, M: Admin (Luk.3/33)  
2, S, El: fehlt in Luk.3/33

Hur  
(1.Chr.4/1)

Jerigoth (w)  
(1.Chr.2/18)

Jeser  
(1.Chr.2/18)

Sobab (1.Chr.2/18)  
Sobal (1.Chr.2/50, 52)

Ardon  
(1.Chr.2/18)

Hur  
(2.Mose31/2; 1.Chr.2/19)

Ashur  
(1.Chr.2/24)

Ashur & Helea  
(1.Chr.4/5)

Amminadab  
Ruth4/19; 1.Chr.2/10;  
Mat.1/3; Luk.3/33)

Sobal  
(1.Chr.4/1)

Jeser  
(1.Chr.2/18)

Sobab (1.Chr.2/18)  
Sobal (1.Chr.2/50, 52)

Ardon  
(1.Chr.2/18)

Kirjath-Jearim  
(1.Chr.2/50)

Haroe  
(1.Chr.2/52)

Bethlehem  
(1.Chr.4/4)

Etam  
(1.Chr.4/3)

Thekoa  
(1.Chr.2/24)

Zereth  
(1.Chr.4/7)

Jizhar  
(1.Chr.4/7)

Z, L84, M: Koz  
(1.Chr.4/7)

Nahesson  
1.Mose1/7; 4.Mose10/14; Ruth4/  
Chr.2/10; Mat.1/3; Luk.3/32)

Reaja  
(1.Chr.4/2)

Kirjath-Jearim  
(1.Chr.2/50)

Haroe  
(1.Chr.2/52)

halbes Volk Manahtiter  
(1.Chr.2/52)

Jesreel  
(1.Chr.4/3)

Jisma  
(1.Chr.4/3)

Anub  
(1.Chr.4/8)

Z: Jaeb  
(1.Chr.4/8)

Salma  
Ruth4/20; 1.Chr.2/11;  
Mat.1/3; Luk.3/32)

Ahumai  
(1.Chr.4/2)

Lahad  
(1.Chr.4/2)

Jidbas  
(1.Chr.4/3)

Hazleponi (w)  
(1.Chr.4/3)

Hazobeba  
(1.Chr.4/8)

Haru  
(1.Chr.4/8)

Boas (von Rahab)  
Ruth4/21; 1.Chr.2/11;  
Mat.1/5; Luk.3/32)

Uri  
(2.Mose31/2; 1.Chr.2/20)

Bezaleel  
(2.Mose31/2; 1.Chr.2/20)

Pnuel  
(1.Chr.4/4)

Gedor  
(1.Chr.4/4)

Sippe Ah  
(1.Chr.4/8)

Eser  
(1.Chr.4/4)



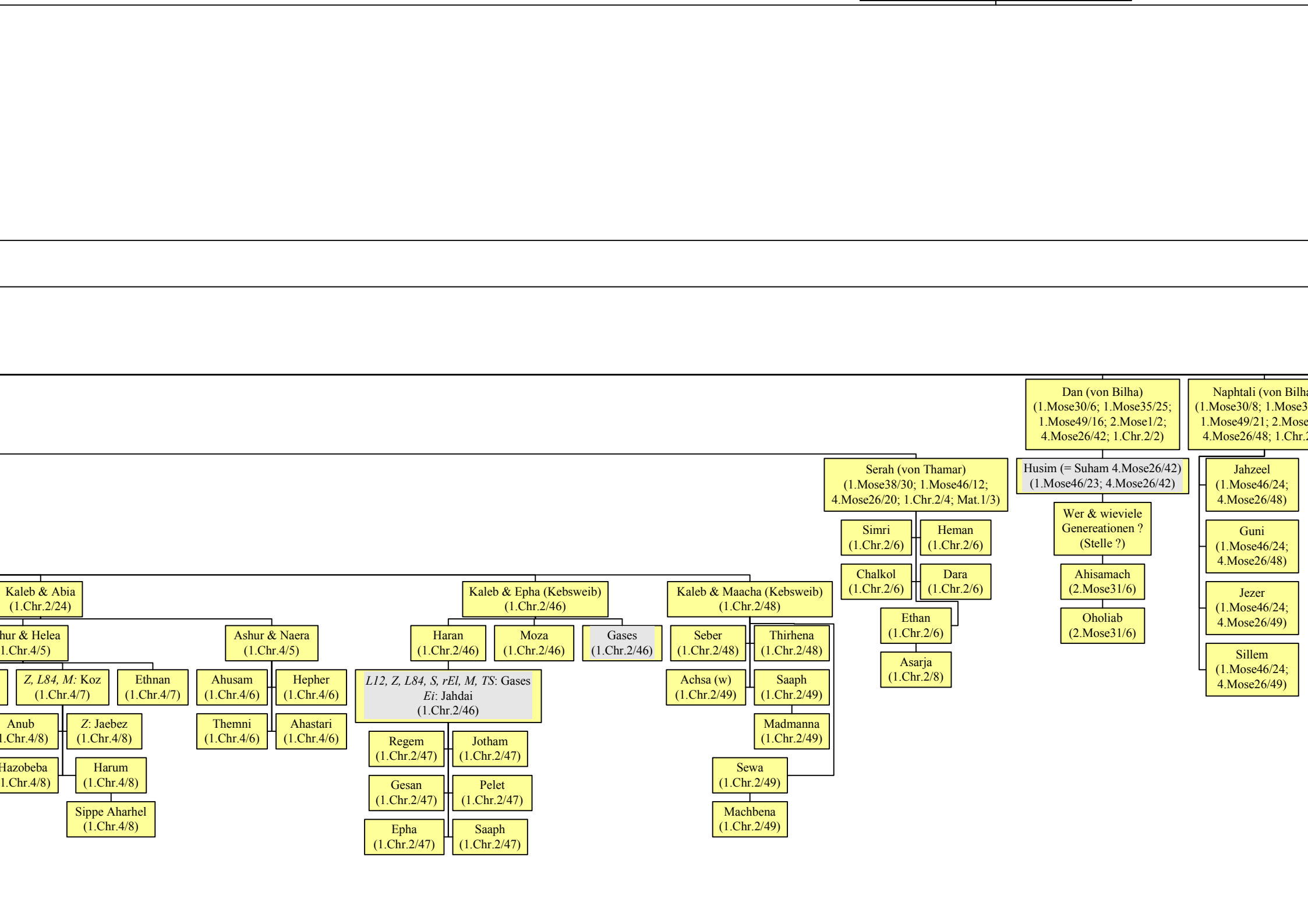

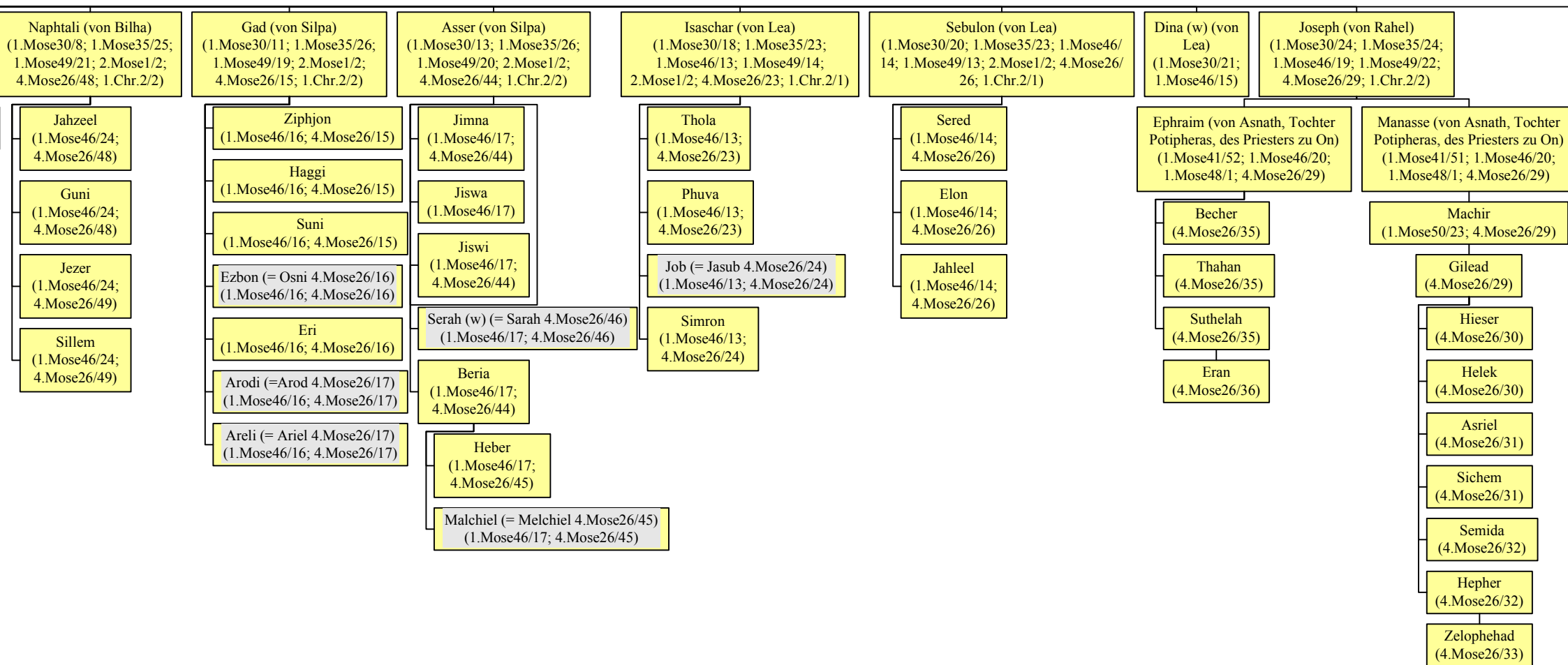

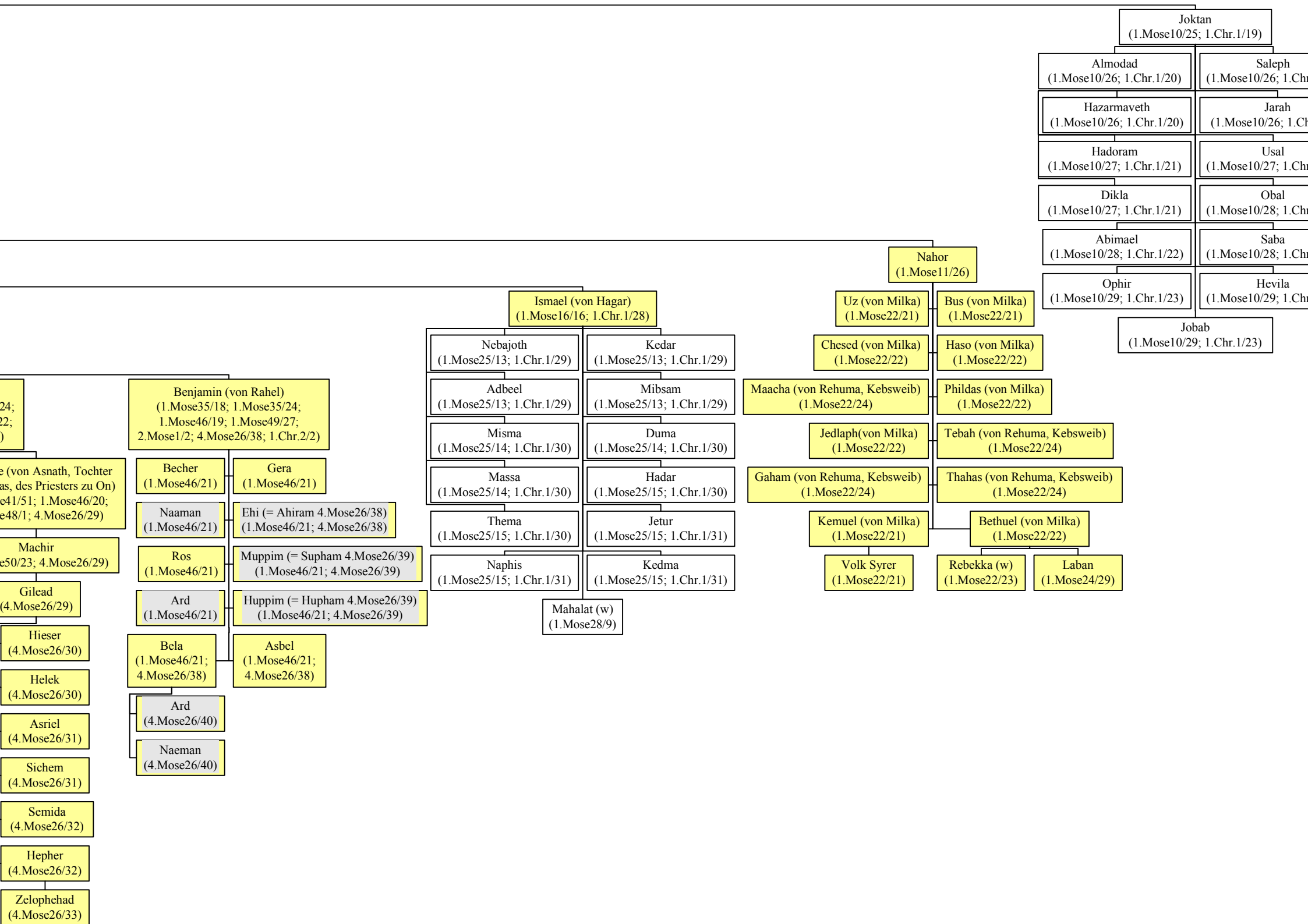

oktan  
(1.Mose10/15; 1.Chr.1/19)

Saleph  
(1.Mose10/26; 1.Chr.1/20)

Jarah  
(1.Mose10/26; 1.Chr.1/20)

Usal  
(1.Mose10/27; 1.Chr.1/21)

Obal  
(1.Mose10/28; 1.Chr.1/22)

Saba  
(1.Mose10/28; 1.Chr.1/22)

Hevila  
(1.Mose10/29; 1.Chr.1/23)

bab  
(1.Mose10/29; 1.Chr.1/23)



(4.Mose26/9)

(1.

(1.

(1.

(1.

(1.

(1.

(1.

(1.

(1.

(1.

Simej  
(1.Chr.4/26)

1. Sohn Simeis  
(1.Chr.4/27)

2. S  
(1

3. Sohn Simeis  
(1.Chr.4/27)

4. S  
(1

5. Sohn Simeis  
(1.Chr.4/27)

6. S  
(1

7. Sohn Simeis  
(1.Chr.4/27)

8. S  
(1

9. Sohn Simeis  
(1.Chr.4/27)

10  
(

11. Sohn Simeis  
(1.Chr.4/27)

12  
(

13. Sohn Simeis  
(1.Chr.4/27)

14  
(

15. Sohn Simeis  
(1.Chr.4/27)

16  
(

1. Tochter Simeis  
(1.Chr.4/27)

2. T  
(

3. Tochter Simeis  
(1.Chr.4/27)

4. T  
(

5. Tochter Simeis  
(1.Chr.4/27)

6. T  
(

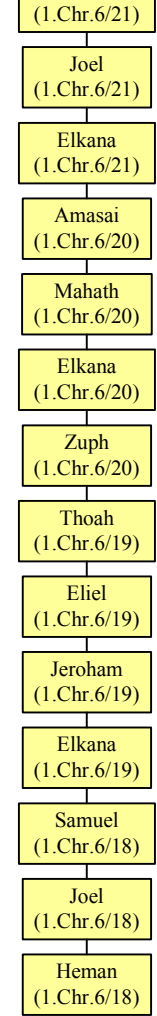
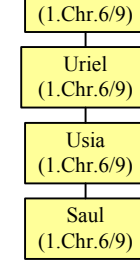
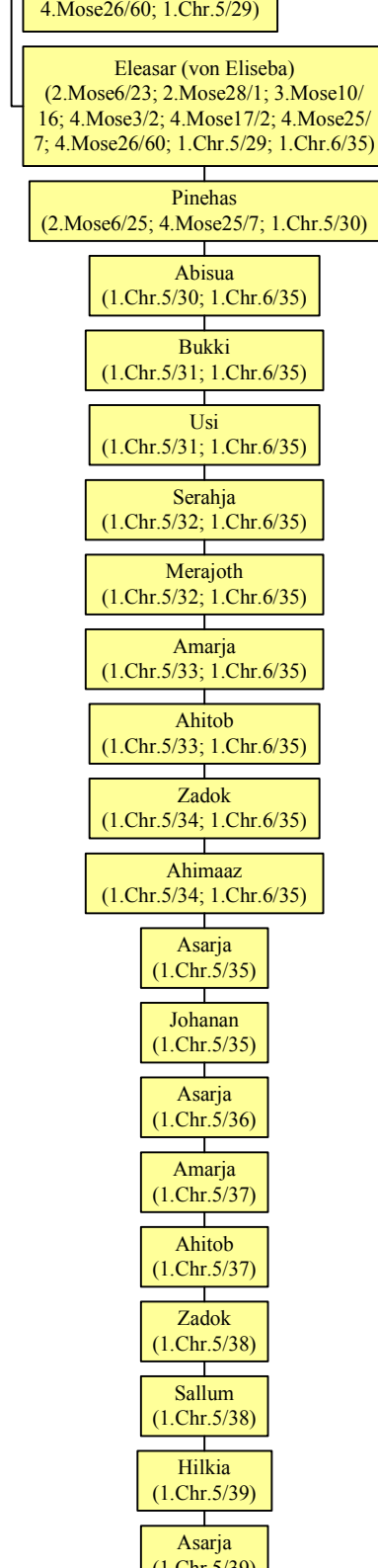
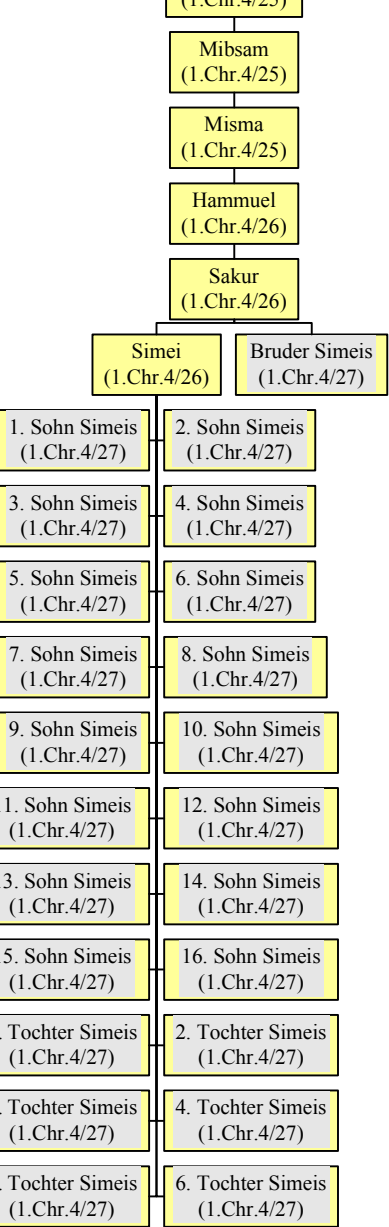

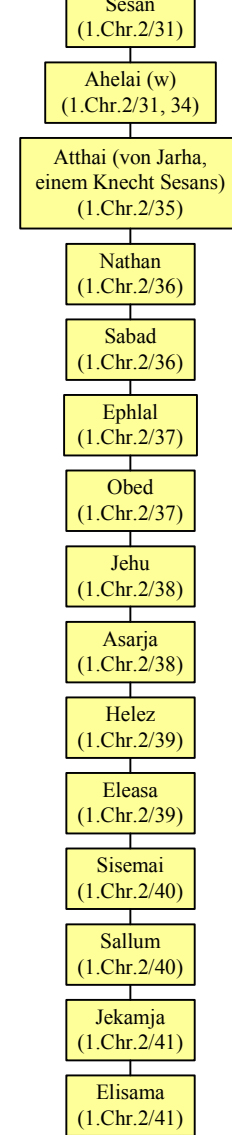
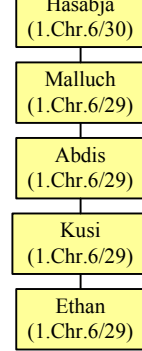
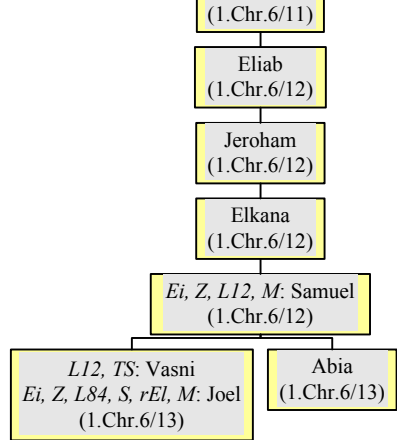



Sasa  
(1.Chr.2/33)

Eker  
(1.Chr.2/27)

Beth-Zur  
(1.Chr.2/45)

Mat.1/5; Luk.3/32

Boas (von Rahab)  
(Ruth4/21; 1.Chr.2/11;  
Mat.1/5; Luk.3/32)

Obed (von Ruth)  
(Ruth4/20; 1.Chr.2/12;  
Mat.1/5; Luk.3/32)

Isai = Jesse  
(Ruth4/20; 1.Chr.2/12;  
Mat.1/5; Luk.3/32)

Eliab  
(1.Chr.2/13)

Abinadab  
(1.Chr.2/13)

Simea  
(1.Chr.2/13)

Nathanael  
(1.Chr.2/14)

Raddai  
(1.Chr.2/14)

Ozem  
(1.Chr.2/15)

Zeruja (w)  
(1.Chr.2/16)

Abigail (w)  
(1.Chr.2/16)

David & Ahinoam (Jesrelitin)  
(1.Chr.3/1)

David & Abigail (Karmelitin)  
(1.Chr.3/1)

David & Maacha (Toch)  
(1.Chr.3/2)

Abisai  
(1.Chr.2/16)

Amasa  
(1.Chr.2/17)

Amnon  
(1.Chr.3/1)

Daniel  
(1.Chr.3/1)

Absalom  
(1.Chr.3/2)

Joab  
(1.Chr.2/16)

Asahel  
(1.Chr.2/16)

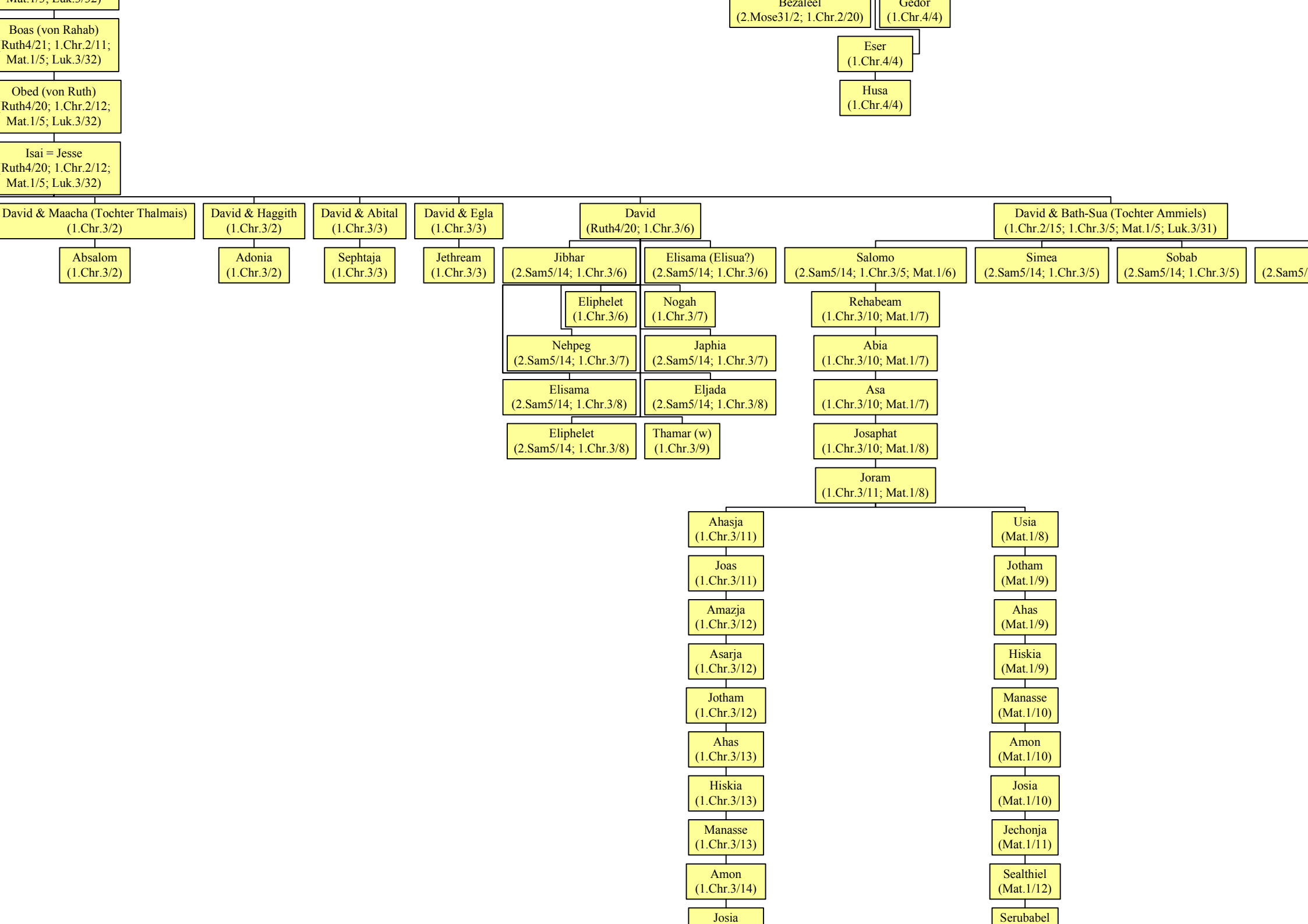

els)  
(Luk.3/31)

ab  
(1.Chr.3/5)

Nathan  
(2.Sam5/14; 1.Chr.3/5; Luk.3/31)

Mattathan  
(Luk.3/31)

Menam  
(Luk.3/31)

Melea  
(Luk.3/31)

Eliakim  
(Luk.3/30)

Jonam  
(Luk.3/30)

Joseph  
(Luk.3/30)

Juda  
(Luk.3/30)

Simeon  
(Luk.3/30)

Levi  
(Luk.3/29)

Matthat  
(Luk.3/29)

Jorem  
(Luk.3/29)

Elieser  
(Luk.3/29)

Jesus  
(Luk.3/29)

Her  
(Luk.3/28)

Elmadam

Jep  
(1.C

(1.C

Iru  
(1.Chr.4/15)

(1.C

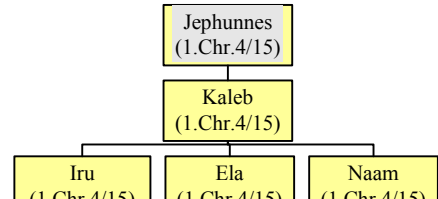
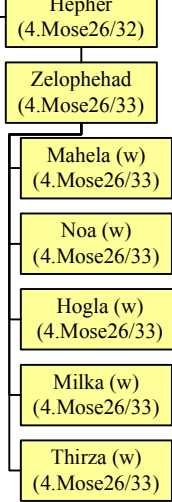











Hilkia  
(1.Chr.5/39)

Asarja  
(1.Chr.5/39)

Seraja  
(1.Chr.5/40)

Jozadak  
(1.Chr.5/40)



